



Resistenza smaltata fissa  
mod. SRS (regolabile SRR)  
*Fixed Vitrified resistor  
type SRS (adjustable SRR)*

-	FD 522410	
-	Revision 8	12.12.2025
-	FD issue	12.06.2019
-	Designed	
	S. Valente	UT
-	Approved	
	C. Mortella	RT

sheet 1 of 7

THIS DOCUMENT IS SUBJECT TO CHANGE WITHOUT NOTICE



I resistori della serie SRS sono stati progettati per applicazioni dove è richiesta un'elevata potenza, robustezza ed eccellente durata. I resistori sono fornibili anche con avvolgimenti anti-induttivi. I resistori SRS sono conformi allo Standard DIN 41432

**MATERIALI IMPIEGATI:**

**Protezione esterna:** Smalto vetroso  
**Elemento resistivo:** Ni-Cr filo o piattina, Constantana filo o piattina  
**Supporto:** Ceramico  
**Terminali:** Collari in ottone nichelato/in acciaio inox AISI 304, IP00

**CARATTERISTICHE PRINCIPALI:**

**Infiammabilità:** Tutti i materiali impiegati sono inorganici e quindi incombustibili e non producono fumo per definizione.

**Resistenza ai solventi:** La smaltatura e la stampigliatura sono inattaccabili dai solventi industriali più comuni.

**CARATTERISTICHE ELETTRICHE:**

**Tolleranza sul valore resistivo:** vedere tabella sotto  
**Coefficiente di temperatura:**  $\leq 100 \text{ ppm} / ^\circ \text{C}$   
**Resistenza di isolamento a secco:**  $> 100 \text{ MOhm} @ 500 \text{Vdc}$   
**Limiti di temperatura:**  $-55^\circ \text{C}; +450^\circ \text{C} (-55^\circ \text{C}; +350^\circ \text{C per SRR})$   
**Costante di tempo:**  $\sim 4 \div 8 \text{ min}$

**Tempo per raggiungere la condizione stazionaria:**  $\sim 13 \div 25 \text{ min}$   
**RESISTORI NON INDUTTIVI:** disponibili come SRSN/SRSNT XX.XXX con avvolgimento Ayrton Perry.

**MARCATURA:** marchio SIR, serie, tipo, valore ohmico, tolleranza, data di produzione (settimana / anno).

**Conforme** con ROHS 3 (UE 2015/863) e REACH (Regolamento CE 1907/2006) e versioni precedenti).

**Serie SRST/SRRT:** Sono i resistori impiegati nella trazione elettrica, progettati per severe condizioni di impiego, quali sovraccarichi ripetuti, shock termici e vibrazioni: la serie SRST è costruita usando la maggiore quantità di filo compatibile con valore ohmico e dimensione del resistore e impiegando materiali e processi idonei per il settore ferroviario. I terminali a collare sono montati con viti e gli avvolgimenti sono realizzati con fili di diametro  $\geq 60 \mu\text{m}$ .

*SRS power resistors are designed for applications where high power, strength and excellent endurance are required. Low self-inductance resistors are available also. The SRS resistors meet DIN 41432 Standard requirements.*

**MATERIAL USED:**

**External protection:** Vitreous enamel  
**Resistive element:** Ni-Cr wire or ribbon, Constantan wire or ribbon  
**Substrate:** Ceramic  
**Terminals:** Nickel plated brass/stainless steel AISI 304 collars, IP00

**MAIN CHARACTERISTICS:**

**Flammability:** All materials are inorganic and inherently no-burning and no-smoking.  
**Solvent resistance:** The vitreous coating and marking are resistant to all common industrial cleaning fluids.  
**ELECTRICAL CHARACTERISTICS:**  
**Resistance tolerance:** see table below  
**Temperature coefficient:**  $\leq 100 \text{ ppm}/^\circ \text{C}$   
**Dry Insulation resistance:**  $> 100 \text{ MOhm} @ 500 \text{Vdc}$   
**Temperature limits:**  $-55^\circ \text{C}; +450^\circ \text{C} (-55^\circ \text{C}; +350^\circ \text{C for SRR})$   
**Time constant:**  $\sim 4 \div 8 \text{ min}$

**Time to reach the steady state:**  $\sim 13 \div 25 \text{ min}$   
**NON INDUCTIVE RESISTORS:** available as SRSN/SRSNT XX.XXX with Ayrton Perry winding.

**MARKING:** SIR Trademark, series, type, Ohmic value, tolerance, date of manufacturing (week/year).

**Compliant** with ROHS 3 (EU 2015/863) and REACH (CE Regulation 1907/2006) and previous releases.

**SRST/SRRT series:** The resistors employed for electrical traction meet severe conditions, as repeated overload, thermal shocks and vibrations: the series SRST is manufactured using the larger quantity of wire compatible with dimensions and resistance value and employing processes and materials suitable for the railway field. The terminal collars or bands are fastened with screws and the winding are made with wires diameter  $\geq 60 \mu\text{m}$ .

Nota: La gamma dei valori resistivi indicata è quella standard, valori differenti possono essere valutati su richiesta.

*The resistance range indicated is the standard one, different values can be evaluated on request.*

**Per i modelli anti induttivi, i valori di resistenza sono più bassi del valore massimo standard.**

*For anti-inductive models, the resistance values are lower than the maximum standard value.*

Se non diversamente specificato, tolleranze applicabili (dimensioni generali/forma) per: ceramica DIN 40680-1/-2 classe g; metallo ISO 2768-1/-2 classe c/L.

*Unless otherwise specified, applicable tolerances (general dimensions/shape) for: ceramic DIN 40680-1/-2 class g; metal ISO 2768-1/-2 class c/L.*

Il presente documento sostituisce/This document replaces FD 520210; FD 520220; FD 520218; FD 520268; FD 520260; FD 520240; FD 521190; FD 520219; FD 520230; FD 521540; FD 521850; FD 522280; FD 522050; FD 522200; FD 522310; FD 522390; FD 522290; FD 521830; FD 521750; FD 521710; FD521930; FD 521950; FD 521590

S.I.R. Società Italiana Resistor

I-21053 Castellanza - Via Isonzo, 13  
Tel. +39 0331.504828 - Fax +39 0331.504565





Resistenza smaltata fissa  
mod. SRS (regolabile SRR)  
*Fixed Vitrified resistor  
type SRS (adjustable SRR)*

- FD 522410  
- Revision 8 12.12.2025  
- FD issue 12.06.2019

- Designed  
S. Valente UT  
- Approved  
C. Mortella RT

sheet 2 of 7

THIS DOCUMENT IS SUBJECT TO CHANGE WITHOUT NOTICE

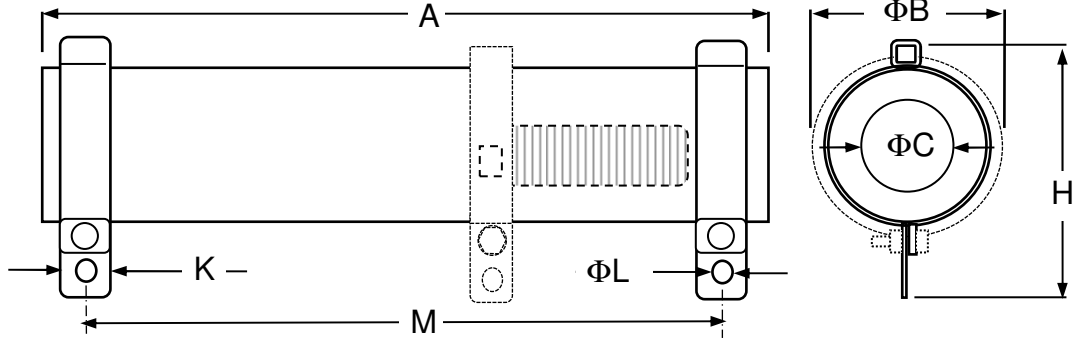

1. Resistore: SRS	13.64	16.90	20.100	20.117	20.120	20.165	20.265	Resistor: SRS		
2. Dimensioni								<i>Dimensions</i>		
A±2,5	64 mm	90 mm	100 mm	117 mm	120 mm	165mm	265 mm	A±2,5		
M±2,5	52 mm	78 mm	82 mm	99 mm	102 mm	147 mm	247 mm	M±2,5		
ΦB±1,5	15 mm	18 mm	22 mm	22 mm	22 mm	22 mm	22 mm	ΦB±1,5		
ΦC±1,5	7 mm	9 mm	9 mm	9 mm	9 mm	9 mm	9 mm	ΦC±1,5		
K±0,2	5 mm	6 mm	8 mm	8 mm	8 mm	8 mm	8 mm	K±0,2		
φL±0,2	3,0 mm	3,0 mm	4,0 mm	4,0 mm	4,0 mm	4,0 mm	4,0 mm	φL±0,2		
H±2	32 mm	36 mm	43 mm	43 mm	43 mm	43 mm	43 mm	H±2		
ΦD±0,5	15 mm	18 mm	22 mm	22 mm	22 mm	22 mm	22 mm	ΦD±0,5		
E±0,5	12 mm	14 mm	18 mm	18 mm	18 mm	18 mm	18 mm	E±0,5		
F±3	26 mm	31 mm	34 mm	34 mm	34 mm	34 mm	34 mm	F±3		
G±2,5	76 mm	102 mm	110 mm	127 mm	130 mm	175 mm	275 mm	G±2,5		
J±3	18,5 mm	20 mm	27 mm	27 mm	27 mm	27 mm	27 mm	J±3		
N±2,5	92 mm	---	160 mm	177 mm	180 mm	225 mm	325 mm	N±2,5		
O±2,5	80 mm	---	130 mm	147 mm	150 mm	195 mm	295 mm	O±2,5		
P±0,1	4,2 mm	---	6,3 mm	6,3 mm	6,3 mm	6,3 mm	6,3 mm	P±0,1		
Q±1	15 mm	---	20 mm	20 mm	20 mm	20 mm	20 mm	Q±1		
R±2	24mm	---	48 mm	48 mm	48 mm	48 mm	48 mm	R±2		
3. Gamma dei valori resistivi	SRS	2,2Ω ÷ 30kΩ	2,2Ω ÷ 56kΩ	2,2Ω ÷ 68kΩ	2,2Ω ÷ 72kΩ	2,2Ω ÷ 70kΩ	2,2Ω ÷ 100kΩ	2,2Ω ÷ 150kΩ	SRS	Resistance range
	SRR	2,2Ω ÷ 3,9kΩ	2,2Ω ÷ 5,6kΩ	2,2Ω ÷ 10kΩ	2,2Ω ÷ 13kΩ	2,2Ω ÷ 12kΩ	2,2Ω ÷ 15kΩ	2,2Ω ÷ 25kΩ	SRR	
	SRSN	2,2Ω ÷ 6,0kΩ	2,2Ω ÷ 11,2kΩ	2,2Ω ÷ 13,6kΩ	2,2Ω ÷ 14kΩ	2,2Ω ÷ 14,4kΩ	2,2Ω ÷ 20kΩ	2,2Ω ÷ 30kΩ	SRSN	
4. Tolleranza	± 10% ± 5% (0+15% SRR)							Tolerance		
5. Temp. superficiale limite	450°C							Surface temperature limit		
6. Tensione limite	(P <sub>R</sub> •R) <sup>0,5</sup>							Limiting voltage		
7. Potenza (P <sub>R</sub> 25°C)	25 W	50 W	60 W	75 W	100 W	110 W	240 W	Rated power (P <sub>R</sub> 25°C)		

S.I.R. Società Italiana Resistor

I-21053 Castellanza - Via Isonzo, 13  
Tel. +39 0331.504828 - Fax +39 0331.504565





Resistenza smaltata fissa  
mod. SRS (regolabile SRR)  
*Fixed Vitrified resistor  
type SRS (adjustable SRR)*

- FD 522410  
- Revision 8 12.12.2025  
- FD issue 12.06.2019

- Designed  
S. Valente UT  
- Approved  
C. Mortella RT

sheet 3 of 7

THIS DOCUMENT IS SUBJECT TO CHANGE WITHOUT NOTICE



1. Resistore: SRS	23.84	23.110	23.127	23.138	23.168	23.265		Resistor: SRS	
<b>2. Dimensioni</b>									
A±2,5	84 mm	110 mm	127 mm	138 mm	168 mm	265 mm		A±2,5	
M±2,5	65 mm	91 mm	108 mm	119 mm	149 mm	246 mm		M±2,5	
ΦB±1,5	25 mm	25 mm	25 mm	25 mm	25 mm	25 mm		ΦB±1,5	
ΦC±1,5	13 mm	13 mm	13 mm	13 mm	13 mm	13 mm		ΦC±1,5	
K±0,2	10 mm	10 mm	10 mm	10 mm	10 mm	10 mm		K±0,2	
φL±0,2	4,0 mm	4,0 mm	4,0 mm	4,0 mm	4,0 mm	4,0 mm		φL±0,2	
H±2	48mm	48 mm	48 mm	48mm	48mm	48mm		H±2	
ΦD±0,5	25 mm	25 mm	25 mm	25 mm	25 mm	25 mm		ΦD±0,5	
E±0,5	18 mm	18 mm	18 mm	18 mm	18 mm	18 mm		E±0,5	
F±3	36 mm	36 mm	36 mm	36 mm	36 mm	36 mm		F±3	
G±2,5	94 mm	120 mm	137 mm	148 mm	178 mm	275 mm		G±2,5	
J±3	28 mm	28 mm	28 mm	28 mm	28 mm	28 mm		J±3	
N±2,5	144 mm	170 mm	187 mm	198 mm	228 mm	325 mm		N±2,5	
O±2,5	112 mm	138 mm	155 mm	166 mm	196 mm	293 mm		O±2,5	
P±0,1	6,3 mm	6,3 mm	6,3 mm	6,3 mm	6,3 mm	6,3 mm		P±0,1	
Q±1	20 mm	20 mm	20 mm	20 mm	20 mm	20 mm		Q±1	
R±2	51 mm	51 mm	51 mm	51 mm	51 mm	51 mm		R±2	
3. Gamma dei valori resistivi	SRS	1,5Ω ÷ 22kΩ	2,0Ω ÷ 50kΩ	2,2Ω ÷ 68kΩ	2,2Ω ÷ 100kΩ	2,2Ω ÷ 100kΩ	2,2Ω ÷ 150kΩ	SRS	Resistance range
	SRR	1,5Ω ÷ 5,0kΩ	2,0Ω ÷ 8,0kΩ	3,3Ω ÷ 10kΩ	3,3Ω ÷ 15kΩ	3,3Ω ÷ 18kΩ	3,3Ω ÷ 33kΩ	SRR	
	SRSN	1,5Ω ÷ 4,4kΩ	2,0Ω ÷ 10kΩ	2,2Ω ÷ 13,6kΩ	2,2Ω ÷ 15kΩ	2,2Ω ÷ 20kΩ	2,2Ω ÷ 30kΩ	SRSN	
4. Tolleranza	± 10% ± 5% (0+15% SRR)						Tolerance		
5. Temp. superficiale limite	450°C						Surface temperature limit		
6. Tensione limite	(P <sub>R</sub> ·R) <sup>0,5</sup>						Limiting voltage		
7. Potenza (P <sub>R</sub> 25°C)	85 W	120 W	90 W	100 W	180 W	240 W	Rated power (P <sub>R</sub> 25°C)		

S.I.R. Società Italiana Resistor  
I-21053 Castellanza - Via Isonzo, 13  
Tel. +39 0331.504828 - Fax +39 0331.504565

1. Resistore: SRS	30.100	30.120	30.165	30.220	30.250	30.265	30.300	Resistor: SRS		
<b>2. Dimensioni</b>										
A±2,5	100 mm	120 mm	165 mm	220 mm	250 mm	265 mm	300 mm	A±2,5		
M±2,5	75 mm	95 mm	140 mm	195 mm	225 mm	240 mm	275 mm	M±2,5		
ΦB±1,5	32 mm	32 mm	32 mm	32 mm	32 mm	32 mm	32 mm	ΦB±1,5		
ΦC±1,5	18 mm	18 mm	18 mm	18 mm	18 mm	18 mm	18 mm	ΦC±1,5		
K±0,2	10 mm	10 mm	10 mm	10 mm	10 mm	10 mm	10 mm	K±0,2		
φL±0,2	4,0 mm	4,0 mm	4,0 mm	4,0 mm	4,0 mm	4,0 mm	4,0 mm	φL±0,2		
H±2	55 mm	55 mm	55 mm	55 mm	55 mm	55 mm	55 mm	H±2		
ΦD±0,5	32 mm	32 mm	32 mm	32 mm	32 mm	32 mm	32 mm	ΦD±0,5		
E±0,5	18 mm	18 mm	18 mm	18 mm	18 mm	18 mm	18 mm	E±0,5		
F±3	44 mm 110 mm	44 mm	44 mm	44 mm	44 mm	44 mm	44 mm	F±3		
G±2,5	mm	130 mm	175 mm	230 mm	260 mm	275 mm	310 mm	G±2,5		
J±3	33 mm	33 mm	33 mm	33 mm	33 mm	33 mm	33 mm	J±3		
N±2,5	158 mm	178 mm	223 mm	278 mm	308 mm	323 mm	358 mm	N±2,5		
O±2,5	126 mm	146 mm	191 mm	246 mm	276 mm	291 mm	326 mm	O±2,5		
P±0,1	6,3 mm	6,3 mm	6,3 mm	6,3 mm	6,3 mm	6,3 mm	6,3 mm	P±0,1		
Q±1	20 mm	20 mm	20 mm	20 mm	20 mm	20 mm	20 mm	Q±1		
R±2	57 mm	57 mm	57 mm	57 mm	57 mm	57 mm	57 mm	R±2		
3. Gamma dei valori resistivi	SRS	3,3Ω ÷ 20kΩ	3,3Ω ÷ 50kΩ	3,3Ω ÷ 100kΩ	3,3Ω ÷ 150kΩ	3,3Ω ÷ 150kΩ	3,3Ω ÷ 150kΩ	4,0Ω ÷ 150kΩ	SRS	Resistance range
	SRR	3,3Ω ÷ 12kΩ	3,5Ω ÷ 16kΩ	3,9Ω ÷ 22kΩ	5,6Ω ÷ 22kΩ	6,0Ω ÷ 30kΩ	6,8Ω ÷ 33kΩ	7,1Ω ÷ 33kΩ	SRR	
	SRSN	3,3Ω ÷ 4,0kΩ	3,3Ω ÷ 10kΩ	3,3Ω ÷ 23kΩ	3,3Ω ÷ 30kΩ	3,3Ω ÷ 30kΩ	3,3Ω ÷ 30kΩ	4,0Ω ÷ 30kΩ	SRSN	
4. Tolleranza	± 10% ± 5% (0+15% SRR)						Tolerance			
5. Temp. superficiale limite	450°C						Surface temperature limit			
6. Tensione limite	(P <sub>R</sub> ·R) <sup>0,5</sup>						Limiting voltage			
7. Potenza (P <sub>R</sub> 25°C)	100 W	120 W	170 W	240 W	260 W	280 W	300 W	Rated power (P <sub>R</sub> 25°C)		





Resistenza smaltata fissa  
mod. SRS (regolabile SRR)  
*Fixed Vitrified resistor  
type SRS (adjustable SRR)*

- FD 522410  
- Revision 8 12.12.2025  
- FD issue 12.06.2019

- Designed  
S. Valente UT  
- Approved  
C. Mortella RT

sheet 4 of 7

THIS DOCUMENT IS SUBJECT TO CHANGE WITHOUT NOTICE



1. Resistore: SRS	30.330	42.168	42.250	42.363	50.373			Resistor: SRS
<b>2. Dimensioni</b>								<b>Dimensions</b>
A±2,5	330 mm	168 mm	250 mm	363 mm	373 mm			A±2,5
M±2,5	305 mm	135 mm	217 mm	330 mm	345 mm			M±2,5
ΦB±1,5	32 mm	43 mm	43 mm	43 mm	51 mm			ΦB±1,5
ΦC±1,5	18 mm	30 mm	30 mm	30 mm	30 mm			ΦC±1,5
K±0,2	10 mm	15 mm	15 mm	15 mm	15 mm			K±0,2
φL±0,2	4,0 mm	6,0 mm	6,0 mm	6,0 mm	6,0 mm			φL±0,2
H±2	55 mm	72 mm	72 mm	72 mm	82 mm			H±2
ΦD±0,5	32 mm	43 mm	43 mm	43 mm	51 mm			ΦD±0,5
E±0,5	18 mm	30 mm	30 mm	30 mm	30 mm			E±0,5
F±3	44 mm	68 mm	68 mm	68 mm	76 mm			F±3
G±2,5	340 mm	178 mm	260 mm	373 mm	383 mm			G±2,5
J±3	33 mm	43 mm	43 mm	43 mm	47 mm			J±3
N±2,5	388 mm	228 mm	310 mm	423 mm	433 mm			N±2,5
O±2,5	356 mm	188 mm	270 mm	383 mm	393 mm			O±2,5
P±0,1	6,3 mm	8 mm	8 mm	8 mm	8 mm			P±0,1
Q±1	20 mm	30 mm	30 mm	30 mm	30 mm			Q±1
R±2	57 mm	87 mm	87 mm	87 mm	95 mm			R±2
3. Gamma dei valori resistivi	SRS	4,7Ω ÷ 150kΩ	5,6Ω ÷ 50kΩ	5,6Ω ÷ 75kΩ	5,6Ω ÷ 100kΩ	5,6Ω ÷ 100kΩ		SRS
	SRR	8,0Ω ÷ 33kΩ	---	---	---	---		SRR
	SRSN	4,7Ω ÷ 30kΩ	5,6Ω ÷ 10kΩ	5,6Ω ÷ 15kΩ	5,6Ω ÷ 20kΩ	5,6Ω ÷ 20kΩ		SRSN
4. Tolleranza	± 10% ± 5% (0+15% SRR)							Tolerance
5. Temp. superficiale limite	450°C							Surface temperature limit
6. Tensione limite	(P <sub>R</sub> ·R) <sup>0,5</sup>							Limiting voltage
7. Potenza (P <sub>R</sub> 25°C)	400 W	240 W	605 W	750 W	900 W			Rated power (P <sub>R</sub> 25°C)

8. Terminali e supporti di fissaggio	Terminals and fixing supports
<p>I resistori regolabili SRR sono normalmente forniti con il cursore inserito e non fissato in una specifica posizione. Su richiesta sono forniti cursori aggiuntivi.</p> <p>Le tipologie di terminali disponibili sono riportate di seguito (per le dimensioni vedere tabelle precedenti):            Terminale TA (SV = TA + vite, dado e rondelle da M3 a M5)            Terminale TB (SS = TB + vite, dado e rondelle da M3 a M5)            Terminale e sistema di fissaggio TS            Terminale FE (ferula con foro filettato M5 o M6)            Sistema di fissaggio SO            Sistema di fissaggio con tirante L            Sistema di fissaggio SB/SC            In assenza di indicazioni nell'ordine, le resistenze saranno fornite con terminale standard TA o TB.</p>	<p>Adjustable resistors SRR are normally supplied with the sliding collar fitted and not locked in any specific position. Additional collars can be supplied on request.</p> <p>The terminals typology available are reported below (for the dimensions see previous tables):            Terminal TA (SV= TA + screws, nut, washer from M3 to M5)            Terminal TB (SS = TB + screws, nut, washer from M3 to M5)            Terminal and fixing support TS            Terminal FE (ferule with threaded hole M5 or M6)            Fixing support SO            Fixing support with tie rod L            Fixing support SB/SC            In absence of any indication in the order, the resistors shall be supplied with terminal standard TA or TB.</p>

Terminal TA

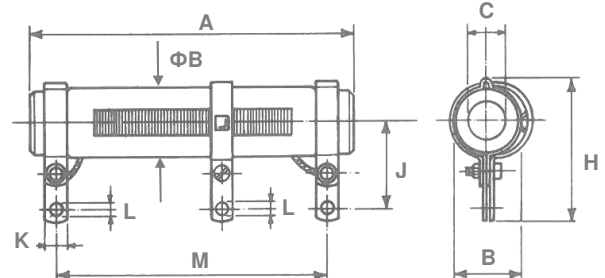
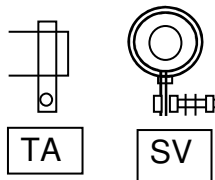

S.I.R. Società Italiana Resistor  
I-21053 Castellanza - Via Isonzo, 13  
Tel. +39 0331.504828 - Fax +39 0331.504565





Resistenza smaltata fissa  
mod. SRS (regolabile SRR)  
*Fixed Vitrified resistor  
type SRS (adjustable SRR)*

- FD 522410
  - Revision 8 12.12.2025
  - FD issue 12.06.2019
- 
- Designed S. Valente UT
  - Approved C. Mortella RT

sheet 5 of 7

THIS DOCUMENT IS SUBJECT TO CHANGE WITHOUT NOTICE



Terminal TB

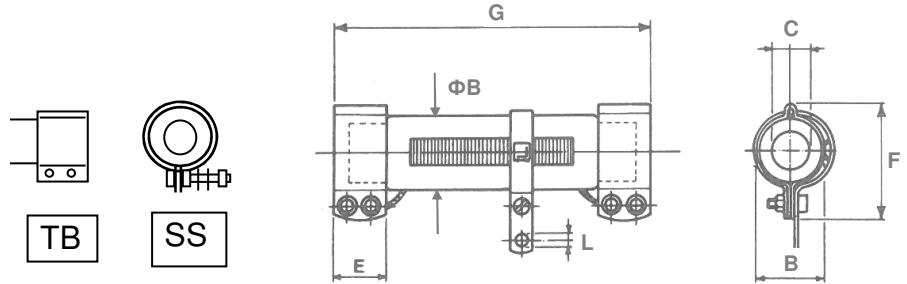

Terminal and fixing support TS

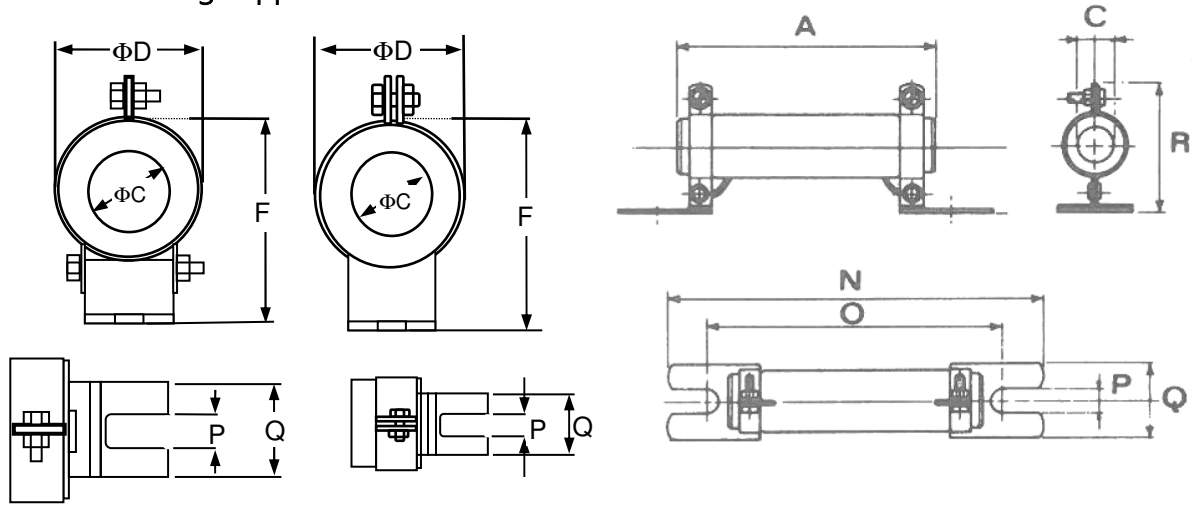

Terminal FE

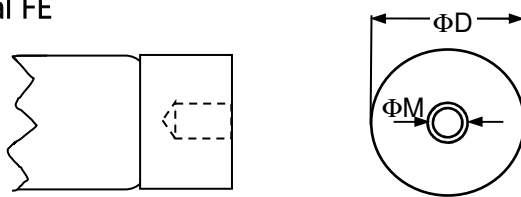

Ferule config. ONLY for	20.XXX	30.XXX
L	A+10 mm	A+15 mm
M	M5	M6
D	22 mm	32,5 mm

Fixing support SO

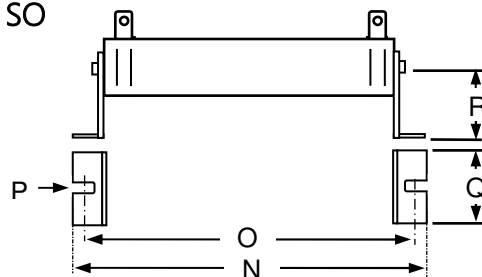

SO	42.XXX 50.XXX 60.XXX
N±2	A+36 mm
O±2	A+24 mm
R±2	65 mm
P±0,2	6,2x12 mm
Q±1	45 mm

Fixing support by tie rod L

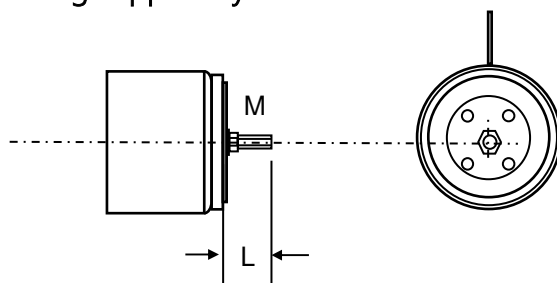

L	30.XXX/42.XXX/50.XXX/60.XXX
L±3	25 mm max
M	Tirante/Tie rod M6 (standard) or M8 (on request) Con dado, rondella spaccata grower, rondella piana With nut, grower washer, flat washer

S.I.R. Società Italiana Resistor  
I-21053 Castellanza - Via Isonzo, 13  
Tel. +39 0331.504828 - Fax +39 0331.504565





Resistenza smaltata fissa  
mod. SRS (regolabile SRR)  
*Fixed Vitrified resistor  
type SRS (adjustable SRR)*

- FD 522410
  - Revision 8 12.12.2025
  - FD issue 12.06.2019
- 
- Designed  
S. Valente UT
  - Approved  
C. Mortella RT

sheet 6 of 7

THIS DOCUMENT IS SUBJECT TO CHANGE WITHOUT NOTICE

Fixing support SB/SC

SB-SC type	Resistor class
13	13.XXX
16-20	16.XXX 20.XXX
23	23.XXX
30	30.XXX

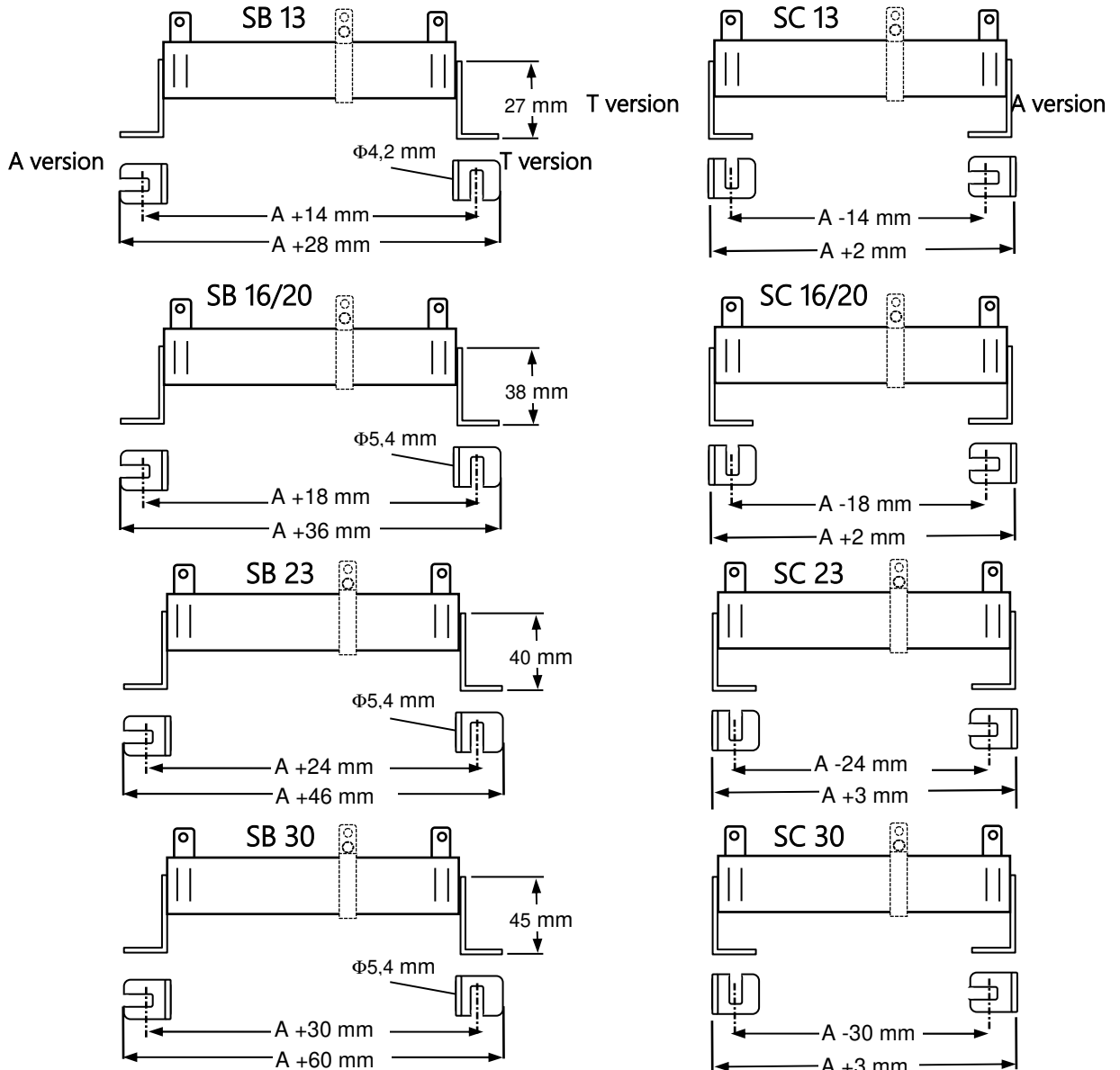

9. CARATTERISTICHE AMBIENTALI E DI DURATA – ENVIRONMENTAL AND ENDURANCE DATA (MIL R 26 D Test procedures)			
TEST	REQUIREMENTS	CONDITIONS	RESULTS
Sovraccarico di breve durata <i>Short time overload</i>	< 2%±0,05Ω	10 Pr during 5 sec., maximum voltage 6000 V or 2,5 times the limit voltage	~0,5%
Shock termici <i>Thermal shock</i>	< 3%±0,05Ω Insulation Resistance > 100 MΩ	-55°C/+200°C 5 cycles MIL STD 202 Test 107G	~0,5%
Umidità (continuativa) <i>Humidity (steady state)</i>	< 2% Insulation Resistance > 100 MΩ	1344 Hours at 95% RH, 40°C MIL STD 202 Method 103B	~0,5%
Umidità ciclica <i>Moisture</i>	< 2% Insulation Resistance > 100 MΩ	10 cycles 55°C/-10°C, Rel. Humidity 95%±100% MIL STD 202 Method 106G	~0,5%
Carico di durata a vita <i>Endurance life load</i>	< 5%	Cycle 90' on/30' off, 2000 h at Pr and 25°C MIL STD 202 Method 108A	~1,5%
Nebbia salina /Salt spray	No pollution or corrosion	MIL STD 202 Method 101E	Passed
Resistenza terminali <i>Terminals strength</i>	1%±0,05Ω resistant	Traction 40 N/Torque 0.60 Nm MIL STD 202 Method 211A	<0,2% No breaking

S.I.R. Società Italiana Resistor  
I-21053 Castellanza – Via Isonzo, 13  
Tel. +39 0331.504828–Fax +39 0331.504565





Resistenza smaltata fissa  
mod. SRS (regolabile SRR)  
*Fixed Vitrifed resistor  
type SRS (adjustable SRR)*

- FD 522410
- Revision 8 12.12.2025
- FD issue 12.06.2019
- Designed S. Valente UT
- Approved C. Mortella RT

sheet 7 of 7

THIS DOCUMENT IS SUBJECT TO CHANGE WITHOUT NOTICE

10. Incremento della temperatura superficiale in funzione della potenza dissipata.

*Surface temperature versus rated power dissipation.*

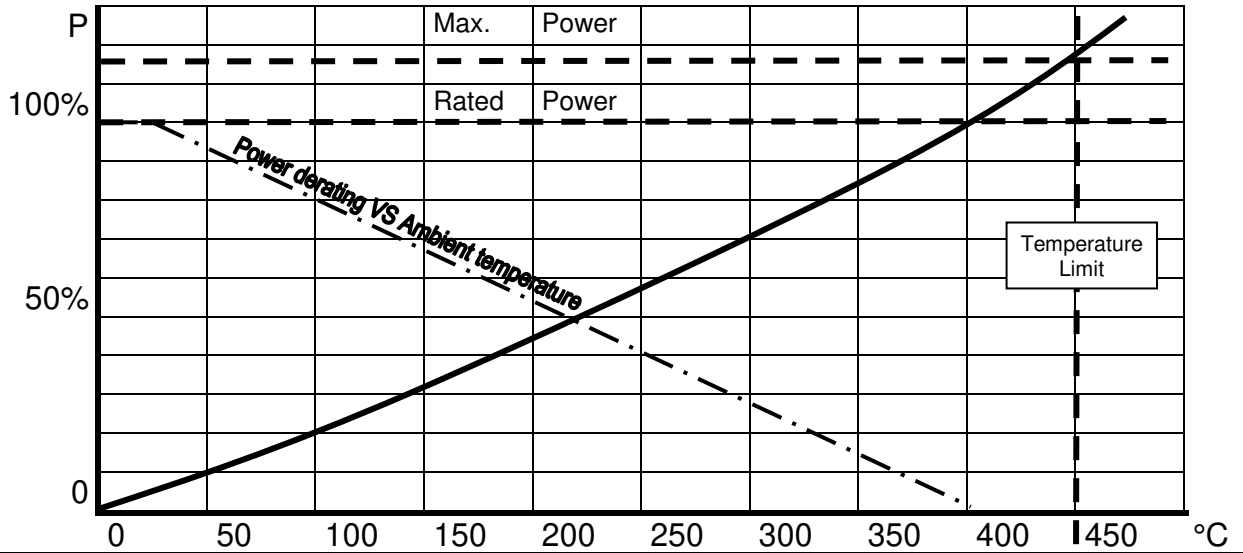

I resistori possono resistere ad elevati sovraccarichi durante un relativo breve istante (on-time). Durante il sovraccarico il materiale attivo raggiunge la massima temperatura. Durante la pausa (off-time) l'energia è rilasciata nell'aria. Il ciclo è il tempo on-time più l'off-time ed è qui considerato 120 secondi. Per altri cicli di carico o per applicazioni continuative particolarmente gravose, per favore consultare il supporto tecnico di SIR. Nota: la Potenza nominale continuativa,  $P_r$ , è stata misurata in condizioni di laboratorio con resistore in condizioni di scambio termico ottimali. Il livello di energia dipende dal valore Ohmico, potenza media e tempo di applicazione (i valori mostrati si riferiscono a 20-40 Ohm).

*The resistors can withstand high overload during relative short time (on-time). During overload the active material reaches maximum temperature. During the resistor period (off-time) the energy is further released into the air. The cycle time is the on-time plus the off-time and taken here as 120 seconds. For other cycle loads or continuous application very stressing, please consult SIR technical support. Note: Continuous Power rating,  $P_r$ , was measured under laboratory conditions with resistor under optimal heat exchange conditions.*

Il livello di energia e di potenza nominale sono massimizzati nel resistore con un basso valore di resistenza (filo con diametro maggiore), mentre per valori Ohmici più alti con diametro del filo inferiore, il livello di energia e la potenza nominale devono essere ridotti proporzionalmente.

*The energy level depends on the Ohmic value, average power and application time (the values shown refer to 20-40 Ohm).*

I modelli anti-induttivi devono essere depotenziati del 25%.

*The energy level and the power rating are maximized in the resistor with low resistance value (wire with higher diameter), while for higher Ohmic values with lower wire diameter, the energy level and the power rating have to be derated proportionally. Anti-inductive models should be de-rated by 25%.*

La curva mostra la capacità di sovraccarico in percentuale della potenza nominale per carichi impulsivi di data durata con un tempo di ciclo di 120 secondi

*Underneath curve shows the overload capability in percentage of the nominal power for pulse loads at given duration with a cycle time of 120 seconds.*

Sovraccarico/Overload @40°C, duty 5 sec, cycle 120 sec.

~10,0 $P_r$

Sovraccarico/Overload @40°C, duty 10 sec, cycle 120 sec.

~5,0 $P_r$

Sovraccarico/Overload @40°C, duty 20 sec, cycle 120 sec.

~2,8 $P_r$

Sovraccarico/Overload @40°C, duty 40 sec, cycle 120 sec.

~1,7 $P_r$

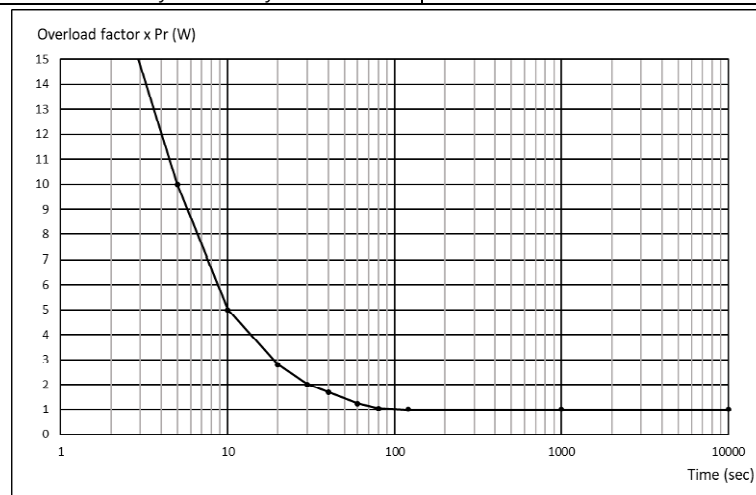

S.I.R. Società Italiana Resistor

I-21053 Castellanza - Via Isonzo, 13  
Tel. +39 0331.504828 - Fax +39 0331.504565

